

Hand-held pressure indicator

Model CPH6200-S1 (1-channel version)

Model CPH6200-S2 (2-channel version)

WIKA data sheet CT 11.01



Applications

- Calibration service companies and service industry
- Measurement and control laboratories
- Quality assurance

Special features

- Digital indicator with interchangeable pressure sensors (plug-and-play)
- Measuring ranges from 0 ... 25 mbar to 0 ... 1,000 bar
- Type of pressure: positive and negative overpressure, absolute pressure and differential pressure
- Accuracy: 0.2 %, optional 0.1 % (incl. calibration certificate)
- Software and complete service cases (incl. pumps) available



Model CPH6200-S1 hand-held pressure indicator with optional model CPT6200 reference pressure sensor

Description

Extensive application possibilities

Stainless steel pressure sensors with measuring ranges up to 1,000 bar are available for the model CPH6200 hand-held pressure indicator. Therefore, it is particularly suitable as a test instrument for applications such as process technology, machine building, etc. The digital indicator automatically detects the measuring range of the connected pressure sensor and guarantees a highly accurate pressure measurement.

Functionality

The CPH6200 can be used for measuring both gauge and absolute pressure. Differential pressure measurement is possible with the 2-channel version CPH6200-S2, and two connected model CPT6200 reference pressure sensors. Selectable pressure units here are bar, mbar, psi, Pa, kPa, MPa, mmHg or inHg.

An integrated data logger and various other functions such as Min, Max, Hold, Tare, zero point adjustment, alarm, power-off, peak value detection (1,000 measurements/s), average value filter, etc. ensure that the CPH6200 can be used for many different applications.

Software

In addition to the GSoft data-logger evaluation software for the tabular and graphical representation of the logged data, WIKA-CAL calibration software for calibration tasks is also available. WIKA-CAL also offers, over and above PC-supported calibration, the management of the calibration and instrument data in an SQL database. For data transfer, an RS-232 and a USB interface are available.

Complete test and service cases

For maintenance and service applications, various service case systems are available. These include service cases with or without pressure generation, rechargeable battery, battery charger, connection adapter, etc.

Certified accuracy

For each reference pressure sensor, the accuracy for the complete measuring chain is certified by a factory calibration certificate which accompanies the instrument. On request, we can provide a DKD/DAkkS calibration certificate for this instrument.

Specifications

Model CPH6200 hand-held pressure indicator (complete measuring chain)									
Measuring inputs	1 input for CPH6200-S1 2 inputs for CPH6200-S2								
Measuring range	mbar	0 ... 25	0 ... 40	0 ... 60	0 ... 100	0 ... 160	0 ... 250	0 ... 400	0 ... 600
Overpressure limit	mbar	500	500	500	1,000	1,500	2,000	2,000	4,000
Burst pressure	mbar	1,000	1,000	1,000	2,000	2,000	2,400	2,400	4,800
Resolution	dependent on pressure range (max. 4 1/2-digit)								
Measuring range	bar	0 ... 1.0	0 ... 1.6	0 ... 2.5	0 ... 4.0	0 ... 6.0	0 ... 10	0 ... 16	0 ... 25
Overpressure limit	bar	5	10	10	17	35	35	80	50
Burst pressure	bar	6	12	12	20.5	42	42	96	250
Resolution	dependent on pressure range (max. 4 1/2-digit)								
Measuring range	bar	0 ... 40	0 ... 60	0 ... 100	0 ... 160	0 ... 250	0 ... 400	0 ... 600	0 ... 1,000
Overpressure limit	bar	80	120	200	320	500	800	1,200	1,500
Burst pressure	bar	400	550	800	1,000	1,200	1,700	2,400	3,000
Resolution	dependent on pressure range (max. 4 1/2-digit)								
Types of pressure	Relative pressure, {absolute pressure from 0 ... 25 bar abs. and vacuum measuring ranges from -1 ... +24 bar}, differential pressure only with CPH6200-S2 and two connected model CPT6200 reference pressure sensors								
Accuracy of the measuring chain	0.2 % FS (resolution 4-digit); {optional: 0.1 % FS (resolution: 4 1/2-digit)}								
Sensor compatibility	Compatible with model CPT6200 reference pressure sensors								

{ } Items in curved brackets are optional extras for an additional price.

Digital indicator model CPH6200	
Indication	
Display	Large 4 1/2-digit LCD display for indication of 2 pressure values and additional information
Indication range	-19999 ... 19999 digits, depending on sensor used
Pressure units	mbar, bar, Pa, kPa, MPa, mmHg, inHg and psi (depending on the measuring range, freely selectable)
Functions	
Measuring rate	4/s ("slow"); 1,000/s ("fast"); > 1,000/s unfiltered (peak value detection), selectable
Memory	Min/Max, integrated data logger
Functions via key press	Min/Max memory, Hold, Tare, zero point adjustment, logger (start/stop)
Menu functions	Min/Max alarm (acoustic/visual), sea level (barometric air pressure), power-off function, measuring rate, average value filter
Average value filter	1 ... 120 seconds, adjustable
Data logger	Individual value logger: up to 99 recordings incl. time via key press Cyclic logger: automatic recording of up to 10,000 values incl. time Cycle time: selectable from 1 ... 3,600 seconds
Real-time clock	integrated clock with date
Voltage supply	
Power supply	9 V battery, alternatively: 9 V rechargeable battery or mains supply
Battery life	> 300 hours of operation (1 sensor with a measuring rate of 4/s)
Permissible ambient conditions	
Operating temperature	0 ... 50 °C
Storage temperature	-20 ... +70 °C
Relative humidity	0 ... 95 % r. h. (non-condensing)
Communication	
Interface	RS-232 or USB via interface cable
Analogue output	DC 0 ... 1 V; configurable (selectable via menu alternative to serial interface)

Digital indicator model CPH6200

Case

Material	Impact-resistant ABS plastic, membrane keypad, transparent screen
Dimensions	see technical drawing
Weight	approx. 160 g (incl. battery)

Reference pressure sensor model CPT6200

Pressure connection ¹⁾	G ½ B; {flush (G 1 for 0.1 up to 1.6 bar) or various connection adapters on request}
-----------------------------------	--

Material

Wetted parts	Stainless steel or Elgiloy®, (> 25 bar additionally with NBR seal) ²⁾ Flush diaphragm version: stainless steel {Hastelloy C4}; O-ring: NBR {FKM/FPM or EPDM}
Internal transmission fluid	Synthetic oil (only for measuring ranges up to 16 bar or flush diaphragm) {Halocarbon oil for oxygen applications}; {Listed by FDA for food industry}

Sensor specifications

Accuracy per year	≤ 0.2 % of span at reference conditions ³⁾
Compensated range	0 ... 80 °C
Mean temperature coefficient	≤ 0.2 % of span/10 K (outside of reference conditions)

Permissible ambient conditions

Medium temperature ¹⁾	-30 ... +100 °C ⁴⁾
Operating temperature	-20 ... +80 °C
Storage temperature	-40 ... +100 °C ⁴⁾
Relative humidity	0 ... 95 % r. h. (non-condensing)

Case

Material	Stainless steel
Connection to the CPH6200	via 1 m connection cable (plug-and-play); optional: up to 5 m
Ingress protection	IP 67
Dimensions	see technical drawing
Weight	approx. 220 g

{ } Items in curved brackets are optional extras for an additional price.

1) As an oxygen version, a flush diaphragm model is not available. In an oxygen version, the model CPT6200 is only available in gauge pressure ranges ≥ 0.25 bar, with media temperatures between -10 ... +50 °C and using stainless steel or Elgiloy® wetted parts.

2) For pressure measuring ranges 0 ... 25 mbar, 0 ... 40 mbar and 0 ... 60 mbar all wetted parts are made of stainless steel, silicon, aluminium, gold, silicone.

3) Reference conditions: 15 ... 25 °C

4) For pressure measuring ranges 0 ... 25 mbar, 0 ... 40 mbar and 0 ... 60 mbar the medium temperature and storage temperature are limited to +80 °C.

CE conformity, approvals, certificates

CE conformity, CPH6200

EMC directive	2004/108/EC, EN 61326 emission (group 1, class B) and interference immunity (portable equipment)
---------------	--

CE conformity, CPT6200

Pressure equipment directive	97/23/EC
EMC directive	2004/108/EC, EN 61326 emission (group 1, class B) and interference immunity (portable equipment)

Approvals

GOST-R	Import certificate, Russia
GOST	Metrology/measurement technology, Russia

Certificates

Calibration	Standard: 3.1 calibration certificate per DIN EN 10204 Option: DKD/DAkkS calibration certificate
-------------	---

Approvals and certificates, see website

Dimensions in mm

Digital indicator CPH6200-S1

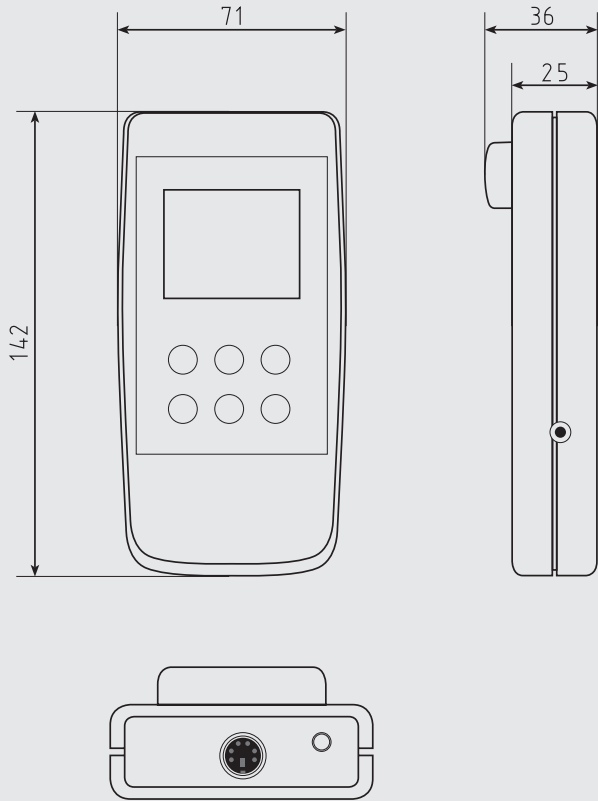

Digital indicator CPH6200-S2

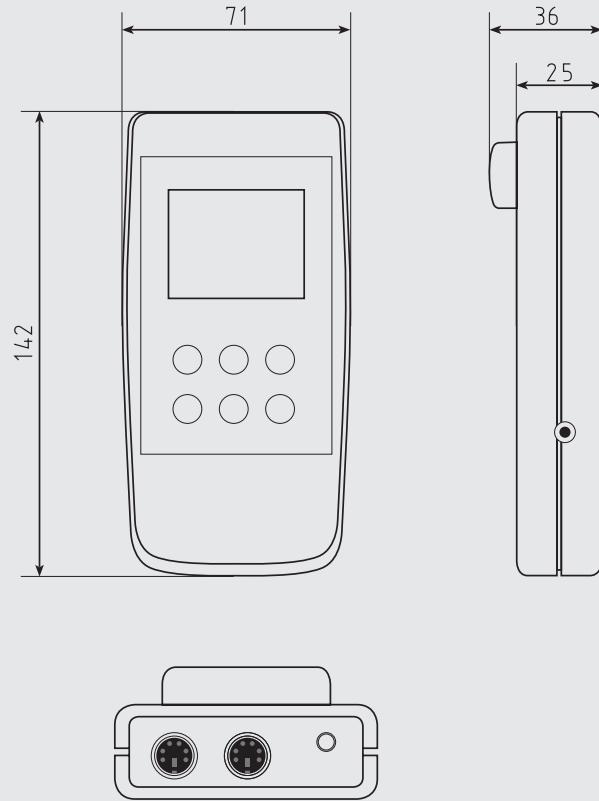

Reference pressure sensor CPT6200

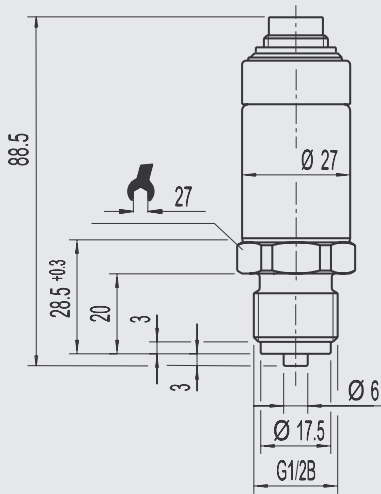

Electrical connections

Model CPH6200-S1

Top view

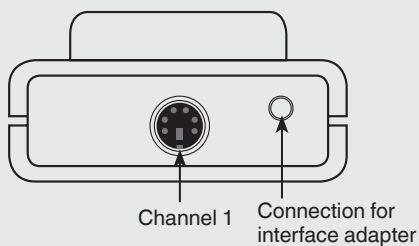

Model CPH6200-S2

Top view

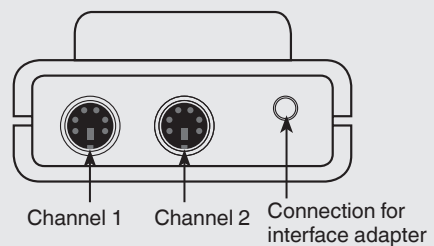

Operating functions of the models CPH6200-S1 and CPH6200-S2

1- and 2-channel version with external pressure sensors

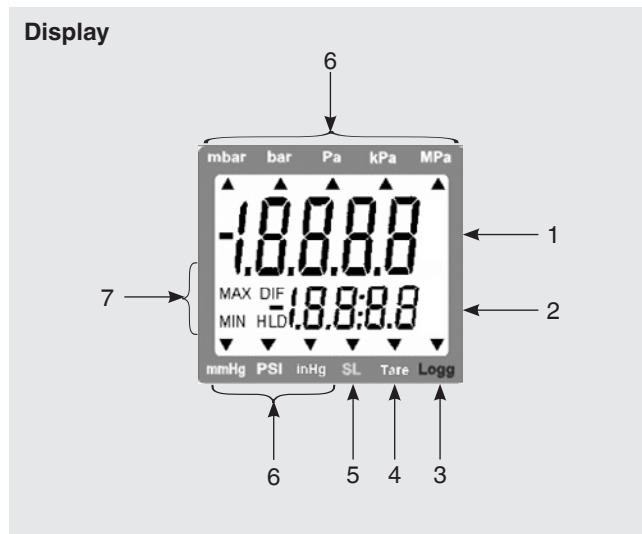

- 1 **Main display:** current measured value for sensor 1
- 2 **Secondary display:** current measured value for sensor 2 or differential value between sensor 1 and sensor 2
- 3 **Logg arrow:** logger is ready
Arrow blinking: automatic recording (Logg CYCL) active
- 4 **Tare arrow:** Tare function was activated
- 5 **SL arrow:** height correction (sea level) was activated
- 6 Display arrows for **measured value units**
- 7 Indication elements for Min/Max measured value illustration

Keyboard

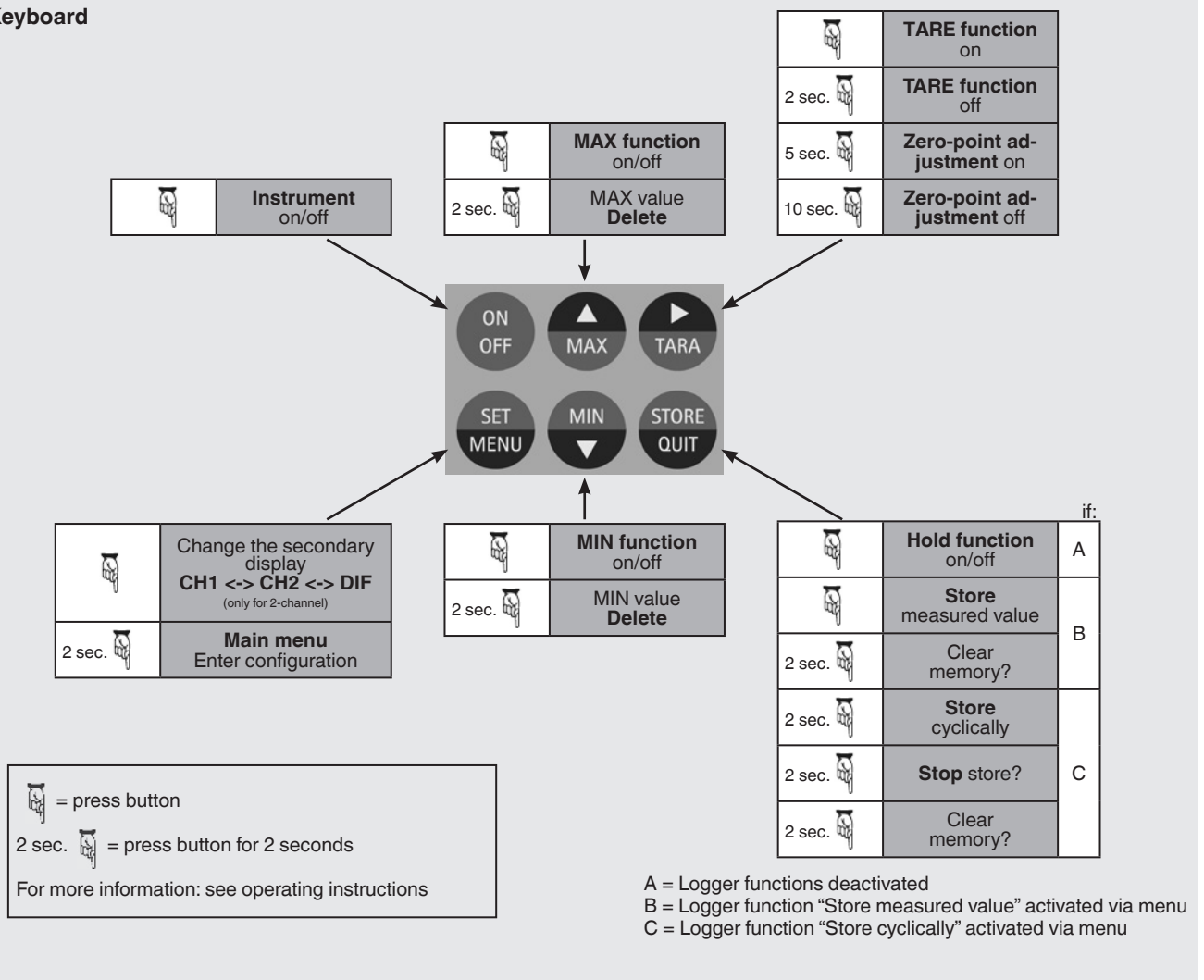

Complete test and service cases



Calibration case with model CPH6200 hand-held pressure indicator for pressure, consisting of:

- Plastic service case with foam insert
- Hand-held pressure indicator model CPH6200
- 9 V battery
- Sealing set
- Sensor cable
- Spaces for several CPT6200 reference pressure sensors

Basic version

Available measuring ranges see specifications

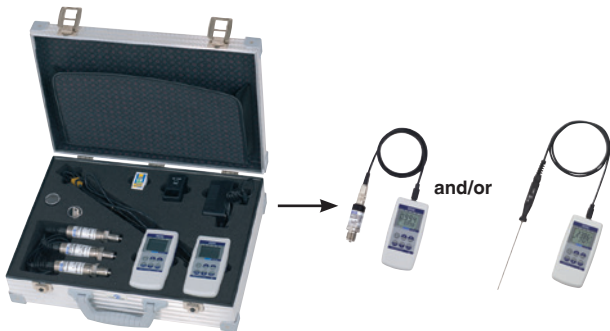

Calibration case for pressure and/or temperature (equipment freely selectable), consisting of:

- Transport case with foam insert and space for max. 2 hand-held pressure indicators/thermometers, several CPT6200 reference pressure sensors, 2 temperature probes, 1 power supply unit, charger and rechargeable battery or battery

Equipment freely selectable

For further specifications see data sheet CT 51.01

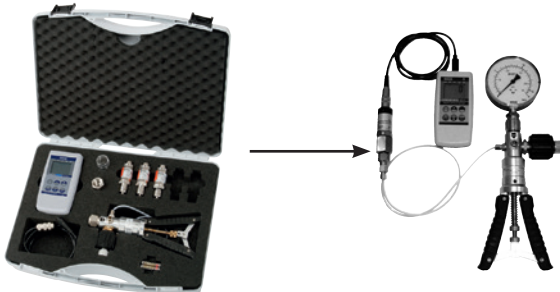

Calibration case with model CPH6200 hand-held pressure indicator and model CPP30 hand test pump for pressures of -0.95 ... +35 bar, consisting of:

- Plastic service case with foam insert
- Hand-held pressure indicator model CPH6200
- Pneumatic hand test pump Model CPP30; -0.95 ... +35 bar
- Sealing set
- Sensor cable
- Rechargeable battery and charger
- Spaces for several CPT6200 reference pressure sensors

Basic version incl. pneumatic pressure generation

Available measuring ranges see specifications

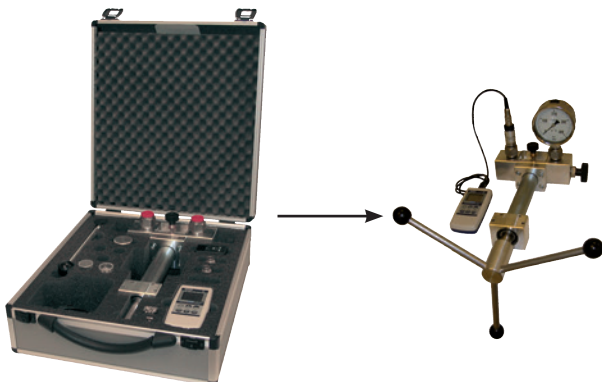

Calibration case with model CPH6200 hand-held pressure indicator and model CPP1000-L hand spindle pump for pressures of 0 ... 1,000 bar, consisting of:

- Transport case with foam insert
- Hand-held pressure indicator model CPH6200
- Hydraulic hand spindle pump model CPP1000-L; 0 ... 1,000 bar
- Sealing set
- Sensor cable
- Rechargeable battery and charger
- Spaces for several CPT6200 reference pressure sensors

Basic version incl. hydraulic pressure generation

Available measuring ranges see specifications

GSoft data-logger evaluation software

The GSoft data-logger evaluation software is used to display the logger data from the model CPH6200 hand-held pressure indicator on a PC in tabular form and as chart.

- Easy operation with self-explanatory toolbars
- Data from the pressure and temperature hand-helds (CTH6200) can be displayed in a single chart (two separate y-axes)
- Chart offers a zoom function
- Operation of the logger function via PC (remote control)
- Data can be exported (Excel®, etc.)
- Languages: German, English, French, Spanish and Czech

System requirements

- IBM compatible PC (Pentium®)
- At least 20 MB free hard disc space
- CD-ROM drive
- At least 32 MB RAM
- Windows® operating system 95, 98, NT 4.0 (with Service Pack 3.0 or higher), 2000, XP, Vista or 7
- Mouse
- One free serial interface or USB connection (via interface cable)

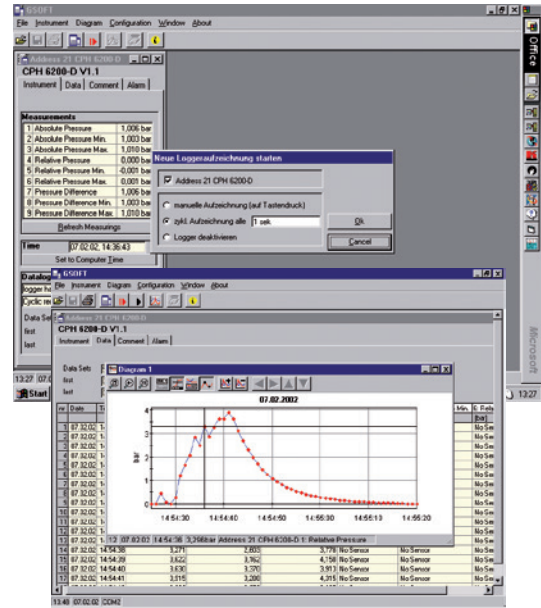

Data export e.g. in an Excel® file

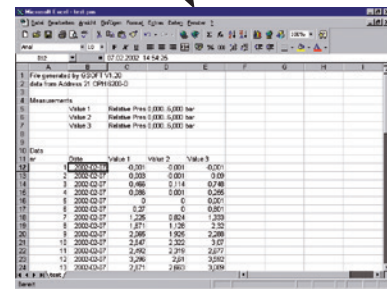

Windows® is a registered trademark of Microsoft Corporation in the United States and other countries.

Easy operation with self-explanatory icon buttons

Main toolbar

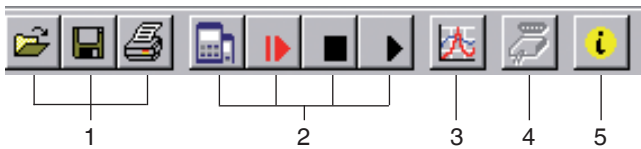

1. File functions: open, save, print
2. Logger functions: start communication, start logger, stop, read data
3. Data display: create chart
4. Interface configuration
5. Program information

Charts toolbar

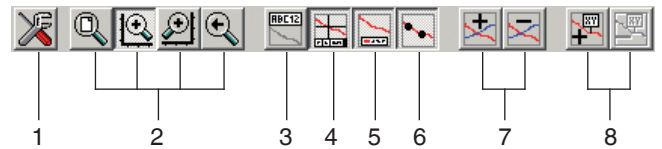

1. Settings: grid and colour settings, manual zooms
2. Zoom: all, left or right y-axis (via mouse), back
3. Rename chart
4. Cursor on/off (info footer)
5. Legend on/off
6. (Measuring point) Symbols on/off
7. Measurement series (add/delete)
8. Comments on measuring points (add/delete)

Scope of delivery

- Hand-held pressure indicator model CPH6200-S1, incl. 9 V battery
- One sensor connection cable per channel
- 3.1 calibration certificate per DIN EN 10204
- Choice of sensors

Options

- Hand-held pressure indicator model CPH6200-S2: 2-channel version (differential pressure measurement possible via 2 connected model CPT6200 reference pressure sensors)
- DKD/DAkkS certified accuracy
- Sensors for oxygen applications



Model CPH6200-S2 hand-held pressure indicator with optional two model CPT6200 reference pressure sensors

Accessories

Connection adapters

- Various pressure adapters
- MINIMESS® quick-connect process connection system

Voltage supply

- Power supply unit
- Rechargeable battery and battery charger

Connection cables

- USB or RS-232 interface cable

Pressure generation

- Pneumatic test pumps
- Hydraulic test pumps

Test cases

- Various calibration cases incl. pressure generation

Software

- GSoft data-logger evaluation software
- WIKA-CAL calibration software

Ordering information

CPH6200 / Instrument version / Additional cable for reference pressure sensor / Power supply unit / Rechargeable battery and battery charger / Software / Interface cable / Test pump / Transport case / Additional order information

CPT6200 / Unit / Measuring range / Accuracy / Process connection / Special design features / Type of certificate / Additional order information

© 2004 WIKA Alexander Wiegand SE & Co. KG, all rights reserved.
The specifications given in this document represent the state of engineering at the time of publishing.
We reserve the right to make modifications to the specifications and materials.

WIKA data sheet CT 11.01 · 07/2014

Page 9 of 9



WIKAL
WIKAL Alexander Wiegand SE & Co. KG
Alexander-Wiegand-Straße 30
63911 Klingenberg/Germany
Tel. +49 9372 132-0
Fax +49 9372 132-406
info@wika.de
www.wika.de