

Miniature resistance thermometer Threaded, explosion-protected version Model TR34

WIKA data sheet TE 60.34



further approvals
see page 9

Applications

- Machine building, plant and vessel construction
- Propulsion technology, hydraulics

Special features

- Intrinsically safe Ex i version, very compact design, high vibration resistance and fast response time
- With direct sensor output (Pt100, Pt1000 in 2-, 3- or 4-wire connection) or integrated transmitter with 4 ... 20 mA output signal
- Integrated transmitter is individually parameterisable with free-of-charge WIKAsoft-TT PC configuration software
- Sensor element with accuracy class A in accordance with IEC 60751

Description

Resistance thermometers of this series are used as universal thermometers for the measurement of liquid and gaseous media in the range $-50 \dots +250 \text{ }^{\circ}\text{C}$ ($-58 \dots +482 \text{ }^{\circ}\text{F}$). The instruments are intrinsically safe and suitable for use in hazardous areas.

They can be used for pressures up to 140 bar with 3 mm sensor diameters and up to 270 bar with 6 mm sensor diameters, depending on the instrument version. All electrical components are protected against humidity (IP67 or IP69K) and designed to withstand vibration (20 g, depending on instrument version).

The resistance thermometer is available with direct sensor output or integrated transmitter, which can be configured individually via the PC configuration software WIKAsoft-TT. Measuring range, damping, fault signal per NAMUR NE43 and TAG no. can be adjusted.



Fig. left: Resistance thermometer, model TR34
Fig. right: M12 x 1 adapter to DIN EN 175301-803 angular connector

Insertion length, process connection, sensor and connection method can each be selected for the respective application within the order information. The model TR34 resistance thermometer consists of a thermowell with a fixed process connection and is screwed directly into the process. The electrical connection is made via an M12 x 1 circular connector. An adapter for electrical connection with angular connector per DIN EN 175301-803 is optionally available (patent, property right: 001370985).

Sensor

The sensor is located in the tip of the thermometer.

The resistance thermometers of the series TR34 are designed for direct installation into the process. Using it in an additional thermowell is not advisable.

Sensor diameter in mm	Process connection						
	G ¼ B	G ⅜ B	G ½ B	¼ NPT	½ NPT	M12 x 1.5	M20 x 1.5
3	x	x	x	x	x	x	x
6	x	x	x	x	x	x	x

Sensor tube length										
Sensor diameter in mm	Insertion length U ₁ in mm									
	50	75	100	120	150	200	250	300	350	400
3	x	-	-	-	-	-	-	-	-	-
6	x	x	x	x	x	x	x	x	x	x

Further sensor tube lengths on request.

Specifications

Thermometer with direct sensor output with Pt100 (model TR34-x-Px) and Pt1000 (model TR34-x-Sx)	
Temperature range	
Class A	Without neck tube -30 ... +150 °C (-22 ... +302 °F) With neck tube -30 ... +250 °C (-22 ... +482 °F)
Class B	Without neck tube -50 ... +150 °C (-58 ... +302 °F) With neck tube -50 ... +250 °C (-58 ... +482 °F)
Temperature at the connector	Max. 85 °C (185 °F)
Measuring element	<ul style="list-style-type: none"> ■ Pt100 (measuring current: 0.1 ... 1.0 mA) ■ Pt1000 (measuring current: 0.1 ... 0.3 mA)
Connection method	<ul style="list-style-type: none"> ■ 2-wire The lead resistance is recorded as an error in the measurement. ■ 3-wire With a cable length of 30 m or longer, measuring deviations can occur. ■ 4-wire The lead resistance can be ignored.
Tolerance value of the measuring element per IEC 60751	<ul style="list-style-type: none"> ■ Class A ■ Class B at 2-wire
Electrical connection	M12 x 1 circular connector (4-pin)
Material of wetted parts	Stainless steel 1.4571
Explosion protection	Intrinsically safe to Ex i (ATEX) gas/dust (for further information see "Further specifications for explosion-protected version")

For detailed specifications for Pt sensors, see Technical information IN 00.17 at www.wika.com.

Thermometer with transmitter and 4 ... 20 mA output signal (model TR34-x-TT)	
Temperature range	Without neck tube -30 ... +150 °C (-22 ... +302 °F) With neck tube -30 ... +250 °C (-22 ... +482 °F) ¹⁾
Measuring element	Pt1000
Connection method	2-wire
Tolerance value of the measuring element per IEC 60751	Class A
Measuring deviation of the transmitter per IEC 60770	±0.25 K
Total measuring deviation in accordance with IEC 60770	Measuring deviation of the measuring element + the transmitter
Measuring span	Minimum 20 K, maximum 300 K
Basic configuration	Measuring range 0 ... 150 °C (32 ... 302 °F), other measuring ranges are adjustable
Analogue output	4 ... 20 mA, 2-wire
Linearisation	Linear to temperature per IEC 60751
Linearisation error	±0.1 % ²⁾
Switch-on delay, electrical	Max. 4 s (time before the first measured value)
Warming-up period	After approx. 4 minutes, the instrument will function to the specifications (accuracy) given in the data sheet.
Current signal for fault signal	Configurable in accordance with NAMUR NE43 downscale ≤ 3.6 mA upscale ≥ 21.0 mA
Sensor short-circuit	Not configurable, in accordance with NAMUR NE43 downscale ≤ 3.6 mA
Sensor current	< 0.3 mA (self-heating can be ignored)
Load R _A	$R_A \leq (U_B - 10 \text{ V}) / 23 \text{ mA}$ with R _A in Ω and U _B in V
Effect of load	±0.05 % / 100 Ω
Power supply U _B	DC 10 ... 30 V
Max. permissible residual ripple	10 % generated by U _B < 3 % ripple of the output current
Power supply input	Protected against reverse polarity
Power supply effect	±0.025 % / V (depending on the power supply U _B)
Influence of the ambient temperature	0.1 % of span / 10 K T _a
Electromagnetic compatibility (EMC) ⁴⁾	EN 61326 emission (group 1, class B) and interference immunity (industrial application) ³⁾ , configuration at 20 % of the full measuring range
Temperature units	Configurable °C, °F, K
Info data	TAG No., description and user message can be stored in transmitter
Configuration and calibration data	Permanently stored
Electrical connection	M12 x 1 circular connector (4-pin)
Material of wetted parts	Stainless steel 1.4571
Explosion protection	Intrinsically safe to Ex i (ATEX) gas/dust (for further information see "Further specifications for explosion-protected version")

Case	
Material	Stainless steel
Ingress protection	
Case with connected connector	IP67 and IP69 per IEC/EN 60529, IP69K per ISO 20653 The stated ingress protection only applies when plugged in using mating connectors that have the appropriate ingress protection.
Coupler connector, not connected	IP67 per IEC/EN 60529
Weight in kg	Approx. 0.2 ... 0.7 (depending on version)
Dimensions	See "Dimensions in mm"

Readings in % refer to the measuring span

1) The temperature transmitter should therefore be protected from temperatures over 85 °C (185 °F).

2) ±0.2 % for measuring ranges with a lower limit less than 0 °C (32 °F)

3) Use resistance thermometers with shielded cable, and ground the shield on at least one end of the lead, if the lines are longer than 30 m or leave the building. The instrument must be operated grounded.

4) During transient interferences (e.g. burst, surge, ESD) take into account an increased measuring deviation of up to 2 %.

Ambient conditions	
Ambient temperature range	
Model TR34-x-TT	-40 ... +85 °C (-40 ... +185 °F)
Models TR34-x-Px, TR34-x-Sx	-50 ... +85 °C (-58 ... +185 °F)
Storage temperature range	-40 ... +85 °C (-40 ... +185 °F)
Climate class per IEC 60654-1	
Model TR34-x-TT	Cx (-40 ... +85 °C or -40 ... +185 °F, 5 ... 95 % r. h.)
Models TR34-x-Px, TR34-x-Sx	Cx (-50 ... +85 °C or -58 ... +185 °F, 5 ... 95 % r. h.)
Maximum permissible humidity per IEC 60068-2-30 var. 2	100 % r. h., condensation allowed
Maximum operating pressure ^{5) 6)}	
With 3 mm sensor diameter	140 bar
With 6 mm sensor diameter	270 bar
Vibration resistance per IEC 60068-2-6	10 ... 2,000 Hz, 20 g ⁵⁾
Shock resistance per IEC 60068-2-27	50 g, 6 ms, 3 axis, 3 faces, 3 times for each face
Salt fog	IEC 60068-2-11

5) Dependent on the instrument version

6) Reduced operating pressure when using a compression fitting: Stainless steel: max. 100 bar / PTFE: max. 8 bar

Further specifications for explosion-protected version

■ Thermometer with transmitter and 4 ... 20 mA output signal (model TR34-x-TT)

Marking:

Hazardous gas atmosphere	Temperature class	Ambient temperature range (T_a)	Maximum surface temperature (T_{max}) at the sensor or thermowell tip
II 1G Ex ia IIC T1 - T6 Ga II 1/2G Ex ia IIC T1 - T6 Ga/Gb II 2G Ex ia IIC T1 - T6 Gb	T6	-40 ... +45 °C	T_M (medium temperature) + self-heating (15 K) Pay attention to the specific conditions for safe use.
	T5	-40 ... +60 °C	
	T4	-40 ... +85 °C	
	T3	-40 ... +85 °C	
	T2	-40 ... +85 °C	
	T1	-40 ... +85 °C	

Hazardous dust atmosphere	Power P_i	Ambient temperature range (T_a)	Maximum surface temperature (T_{max}) at the sensor or thermowell tip
II 1D Ex ia IIIC T135 °C Da II 1/2D Ex ia IIIC T135 °C Da/Db II 2D Ex ia IIIC T135 °C Db	750 mW	-40 ... +40 °C	T_M (medium temperature) + self-heating (15 K) Pay attention to the specific conditions for safe use.
	650 mW	-40 ... +70 °C	
	550 mW	-40 ... +85 °C	

Safety-related maximum values for the current loop circuit (+ and - connections):

Parameters	Hazardous gas atmosphere	Hazardous dust atmosphere
Terminals	+ / -	+ / -
Voltage U_i	DC 30 V	DC 30 V
Current I_i	120 mA	120 mA
Power P_i	800 mW	750/650/550 mW
Effective internal capacitance C_i	29.7 nF	29.7 nF
Effective internal inductance L_i	Negligible	Negligible
Maximum self-heating at the sensor or thermowell tip	15 K	15 K

■ Thermometer with direct sensor output with Pt100 (model TR34-x-Px) and Pt1000 (model TR34-x-Sx)

Marking:

Marking	Temperature class	Ambient temperature range (T _a)	Maximum surface temperature (T _{max}) at the sensor or thermowell tip
II 1G Ex ia IIC T1 - T6 Ga II 1/2G Ex ia IIC T1 - T6 Ga/Gb II 2G Ex ia IIC T1 - T6 Gb	T6	-50 ... +80 °C	T _M (medium temperature) + self-heating Pay attention to the specific conditions for safe use.
	T5	-50 ... +85 °C	
	T4	-50 ... +85 °C	
	T3	-50 ... +85 °C	
	T2	-50 ... +85 °C	
	T1	-50 ... +85 °C	

Marking	Power P _i	Ambient temperature range (T _a)	Maximum surface temperature (T _{max}) at the sensor or thermowell tip
II 1D Ex ia IIIC T135 °C Da II 1/2D Ex ia IIIC T135 °C Da/Db II 2D Ex ia IIIC T135 °C Db	750 mW	-50 ... +40 °C	T _M (medium temperature) + self-heating Pay attention to the specific conditions for safe use.
	650 mW	-50 ... +70 °C	
	550 mW	-50 ... +85 °C	

Safety-related maximum values for the current loop circuit (connections in accordance with pin assignment 1 - 4):

Parameters	Gas applications	Dust applications
Terminals	1 - 4	1 - 4
Voltage U _i	DC 30 V	DC 30 V
Current I _i	550 mA	250 mA
Power P _i	1.500 mW	750/650/550 mW
Effective internal capacitance C _i	Negligible	Negligible
Effective internal inductance L _i	Negligible	Negligible
Maximum self-heating at the sensor or thermowell tip	(R _{th}) = 335 K/W	(R _{th}) = 335 K/W

Configuration software WIKAsoft-TT

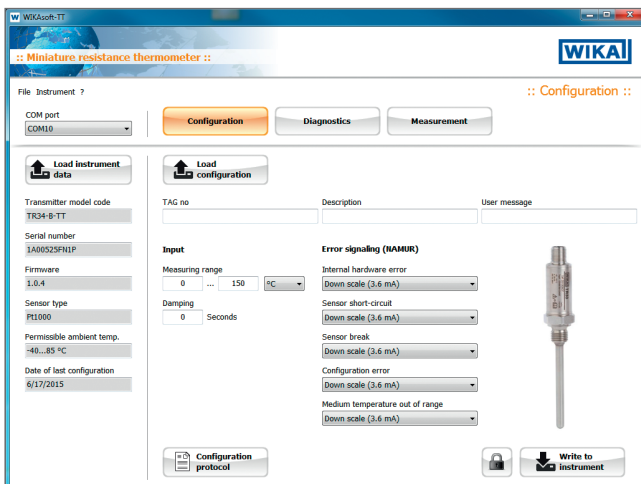

Configuration software (multilingual) as a download from www.wika.com

Dimensions in mm

Process connection with parallel threads (or without process connection)

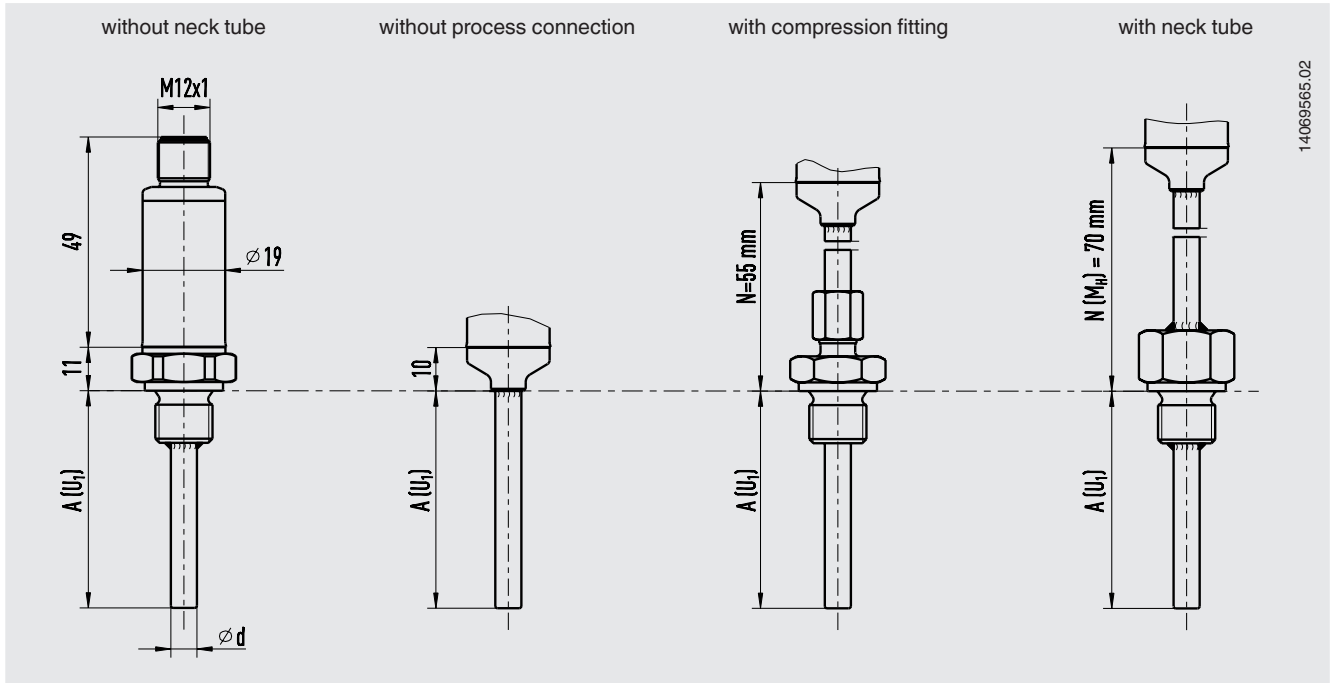

14069565.02

Process connection with tapered thread

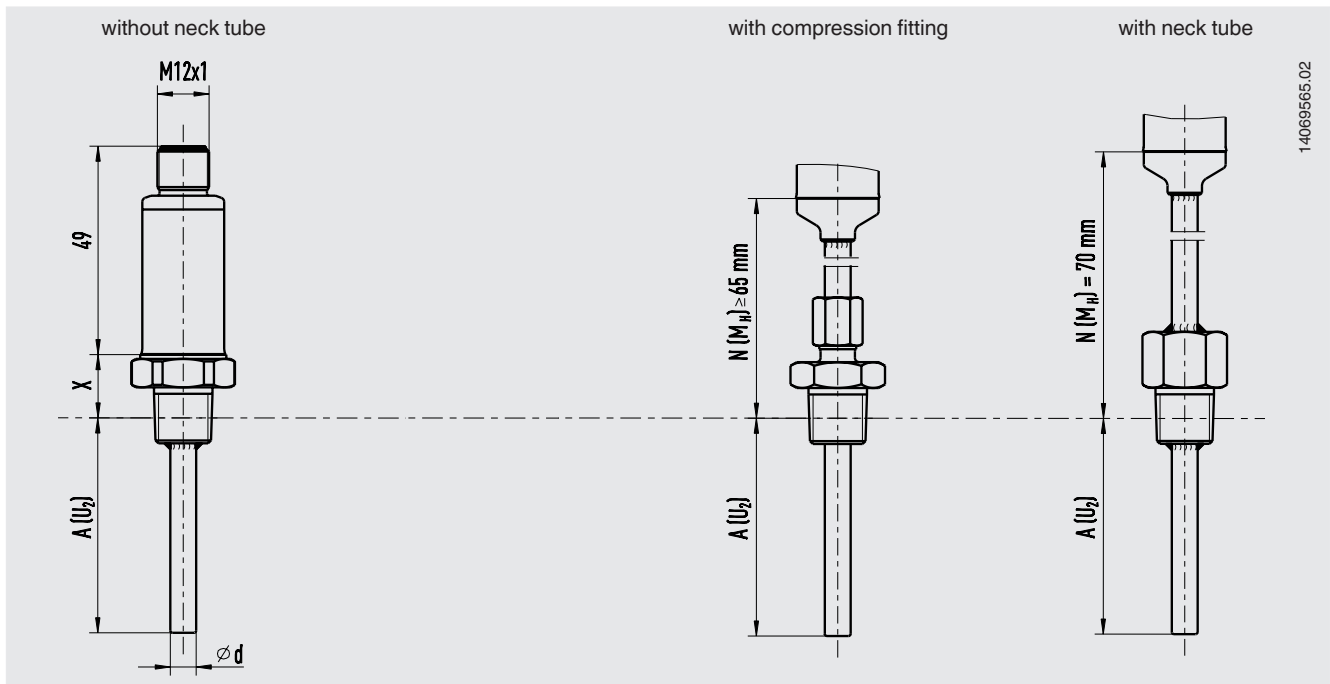





14069565.02

1) At a process temperature of > 150 °C (302 °F), a neck length N (MH) of 70 mm is necessary, otherwise N (MH) selectable (55, 65 or 70 mm).

Legend:

- A (U₁) Insertion length (parallel thread)
- A (U₂) Insertion length (tapered thread)
- N (M_H) Neck length
- Ød Sensor diameter
- X Height process connection
- 1/4 NPT = 15 mm
- 1/2 NPT = 19 mm

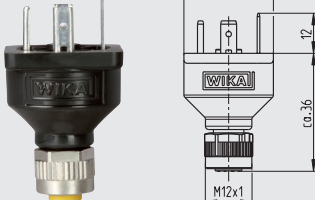
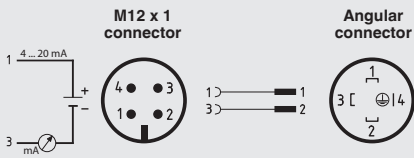
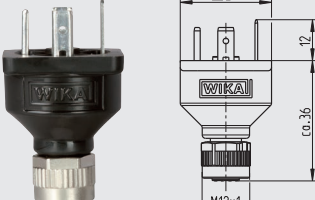
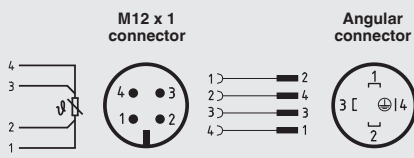
Accessories

Model	Special features	Order no.
Programming unit Model PU-548 	<ul style="list-style-type: none"> ■ Easy to use ■ LED status display ■ Compact design ■ No further voltage supply needed, neither for the programming unit nor for the transmitter <p>(replaces programming unit model PU-448)</p>	14231581
Adapter cable M12 to PU-548 	Adapter cable for the connection of a model TR34 resistance thermometer to the model PU-548 programming unit	14003193
M12 x 1 transmitter adapter to angular connector DIN EN 175301-803 (yellow female connector element) 	Adapter for the connection of a resistance thermometer with a DIN EN 175301-803 form A angular connector with a 4 ... 20 mA output signal (data sheet AC 80.17)  <p>Case: PA Ambient temperature: -40 ... +115 °C Union nut: zinc diecast Contacts: copper-zinc alloy, tin-plated Dielectric strength: 500 V Ingress protection: IP65</p>	14069503
M12 x 1 Pt adapter to angular connector DIN EN 175301-803 (black female connector element) 	Adapter for the connection of the resistance thermometer with a DIN EN 175301-803 form A angular connector with direct resistance output signal (data sheet AC 80.17)  <p>Case: PA Ambient temperature: -40 ... +115 °C Union nut: zinc diecast Contacts: copper-zinc alloy, tin-plated Dielectric strength: 500 V Ingress protection: IP65</p>	14061115
Angular connector 	per DIN EN 175301-803 form A	11427567
Sealing for angular connector 	for use with angular connector DIN EN 175301-803-A EPDM, brown	11437902
M12 connection cable	Cable socket straight, 4-pin, ingress protection IP67 <ul style="list-style-type: none"> ■ Temperature range -20 ... +80 °C 	Cable length 2 m 14086880 Cable length 5 m 14086883
	Angled socket, 4-pin, ingress protection IP67 <ul style="list-style-type: none"> ■ Temperature range -20 ... +80 °C 	Cable length 2 m 14086889 Cable length 5 m 14086891
	M12 connector	14136815
	Female angled, 4-pin, ingress protection IP67 Screw connection for conductor cross-section 0.25 ... 0.75 mm ² (24 ... 18 AWG) Cable gland Pg7, cable outer diameter 4 ... 6 mm <ul style="list-style-type: none"> ■ Temperature range -40 ... +80 °C ■ Suitable for hazardous areas 	

Connecting PU-548 programming unit

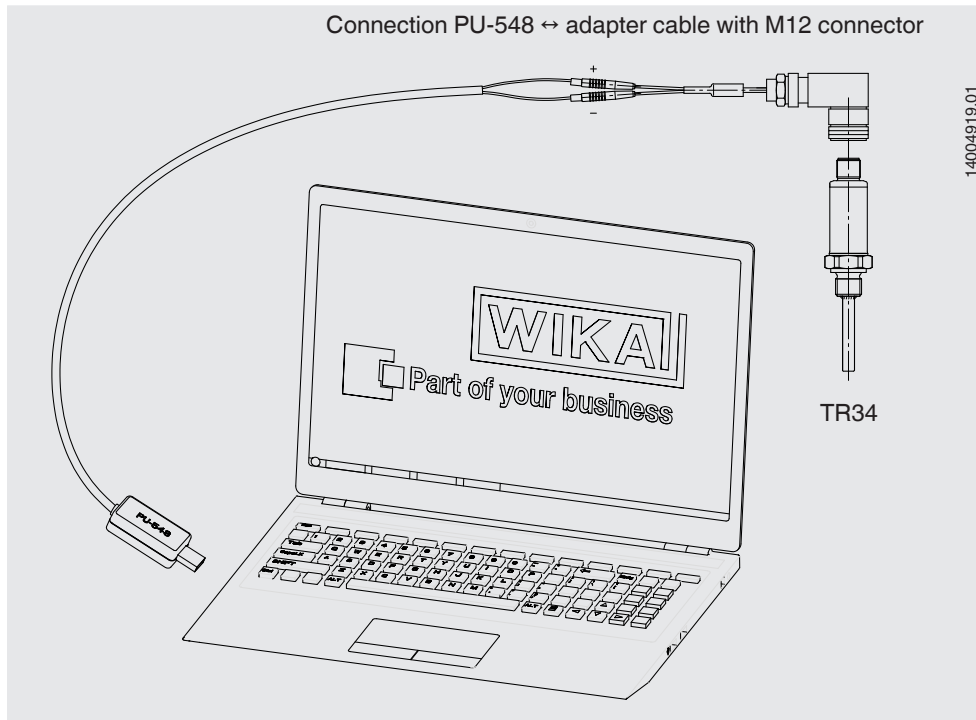

(predecessor, programming unit model PU-448, also compatible)

Electrical connection

Output signal 4 ... 20 mA

M12 x 1, 4-pin circular connector

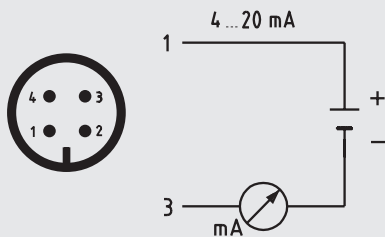

Pin	Signal	Description
1	L+	10 ... 30 V
2	VQ	not connected
3	L-	0 V
4	C	not connected

Output signal Pt100 or Pt1000 sensor

M12 x 1, 4-pin circular connector

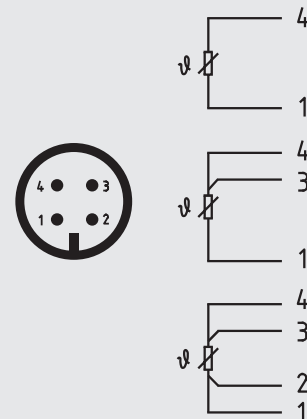





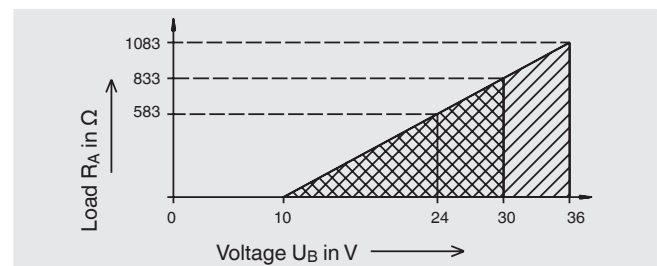









Load diagram

The permissible load depends on the loop supply voltage. For communication with the instrument with programming unit PU-548, a max. load of 350 Ω is admissible.



Approvals

Logo	Description	Country
 	EU declaration of conformity <ul style="list-style-type: none"> ■ EMV directive ¹⁾ EN 61326 emission (group 1, class B) and interference immunity (industrial application) ■ RoHS directive ■ ATEX directive Hazardous areas Zone 0 gas [II 1G Ex ia IIC T1 ... T6 Ga] Zone 1 mounting to zone 0 gas [II 1/2G Ex ia IIC T1 ... T6 Ga/Gb] Zone 1 gas [II 2G Ex ia IIC T1 ... T6 Gb] Zone 20 dust [II 1D Ex ia IIIC T135 °C Da] Zone 21 mounting to zone 20 dust [II 1/2D Ex ia IIIC T135 °C Da/Db] Zone 21 dust [II 2D Ex ia IIIC T135 °C Db] 	European Union
 	IECEx (option) - in conjunction with ATEX Hazardous areas Zone 0 gas [Ex ia IIC T1 ... T6 Ga] Zone 1 mounting to zone 0 gas [Ex ia IIC T1 ... T6 Ga/Gb] Zone 1 gas [Ex ia IIC T1 ... T6 Gb] Zone 20 dust [Ex ia IIIC T135 °C Da] Zone 21 mounting to zone 20 dust [Ex ia IIIC T135 °C Da/Db] Zone 21 dust [Ex ia IIIC T135 °C Db]	International
	CSA (option) <ul style="list-style-type: none"> ■ Safety (e.g. electr. safety, overpressure, ...) ■ Hazardous areas - Ex i (for Canada) Division 1 gas [CL I, DIV 1, GP A, B, C, D, T1 ... T6] Division 2 gas [CL I, DIV 2, GP A, B, C, D, T1 ... T6] Division 1 dust [CL II / III, DIV 1, GP E, F, G, T135 °C] Division 2 dust [CL II / III, DIV 2, GP E, F, G, T135 °C] Zone 0 gas [Ex ia IIC T1...T6 Ga] Zone 1 gas [Ex ia IIC T1...T6 Gb] Zone 20 dust [Ex ia IIIC T135 °C Da] Zone 21 dust [Ex ia IIIC T135 °C Db] - Ex i (for USA) Division 1 gas [CL I, DIV 1, GP A, B, C, D, T1 ... T6] Division 2 gas [CL I, DIV 2, GP A, B, C, D, T1 ... T6] Division 1 dust [CL II / III, DIV 1, GP E, F, G, T135 °C] Division 2 dust [CL II / III, DIV 2, GP E, F, G, T135 °C] Zone 0 gas [CL I, zone 0, IIC AEX ia T1 ... T6 Ga] Zone 1 gas [CL I, zone 1, IIC AEX ia T1 ... T6 Gb] Zone 20 dust [CL II, zone 20, IIIC AEX ia T135 °C Da] Zone 21 dust [CL II, zone 21, IIIC AEX ia T135 °C Db] 	USA and Canada
 	EAC (option) <ul style="list-style-type: none"> ■ EMC directive ¹⁾ ■ Hazardous areas Zone 0 gas [0 Ex ia IIC T6...T1 Ga X] Zone 1 gas [1 Ex ia IIC T6...T1 Gb X] Zone 20 dust [Ex ia IIIC T80...T440 Da X] Zone 21 dust [Ex ia IIIC T80...T440 Db X] 	Eurasian Economic Community
	INMETRO (option) Hazardous areas Zone 0 gas [Ex ia IIC T1...T6 Ga] Zone 1 mounting to zone 0 gas [Ex ia IIC T1...T6 Ga/Gb] Zone 1 gas [Ex ia IIC T1...T6 Gb] Zone 20 dust [Ex ia IIIC T135 °C Da] Zone 21 mounting to zone 20 dust [Ex ia IIIC T135 °C Da/Db] Zone 21 dust [Ex ia IIIC T135 °C Db]	Brazil

Logo	Description	Country
	NEPSI (option) Hazardous areas Zone 0 gas [Ex ia IIC T1 ~ T6 Ga] Zone 20 dust [Ex iaD 20 T135]	China
	DNOP - MakNII (option) Mining	Ukraine
	GOST (option) Metrology, measurement technology	Russia
	KazInMetr (option) Metrology, measurement technology	Kazakhstan
-	MTSCHS (option) Permission for commissioning	Kazakhstan
	BelGIM (option) Metrology, measurement technology	Belarus
	UkrSEPRO (option) Metrology, measurement technology	Ukraine
	Uzstandard (option) Metrology, measurement technology	Uzbekistan

1) Only for built-in transmitter

Certificates (option)

Certification type	Measuring accuracy	Material certificate
2.2 test report	x	x
3.1 inspection certificate	x	x
DKD/DAkkS calibration certificate	x	-

The different certifications can be combined with each other.

Approvals and certificates, see website

Patents, property rights

M12 x 1 adapter to DIN EN 175301-803 angular connector (001370985)

Ordering information

Model / Explosion protection / Output signal / Transmitter temperature unit / Process temperature / Transmitter initial value / Transmitter end value / Process connection / Sensor diameter / Insertion length A (U₁) or A (U₂) / Neck length N (M_H) / Accessories / Certificates

© 11/2014 WIKA Alexander Wiegand SE & Co. KG, all rights reserved.
The specifications given in this document represent the state of engineering at the time of publishing.
We reserve the right to make modifications to the specifications and materials.

Explosion protection

Resistance thermometers of the TR34 series have an EC-type examination certificate for “intrinsically safe”, Ex i, ignition protection.

These instruments comply with the requirements of the ATEX directive for gases and dusts.

The permissible power, P_{max}, as well as the permissible ambient temperature, for the respective category can be seen on the EC-type examination certificate, the certificate for hazardous areas or in the operating instructions.

