



Pneumatické spojky vhodné pro
všechna průmyslová odvětví

Velký rozsah velikostí od 3 do 16 mm

Miniaturní spojky řady Pneufit® M.

METRICKÁ ŘADA PNEUFIT C

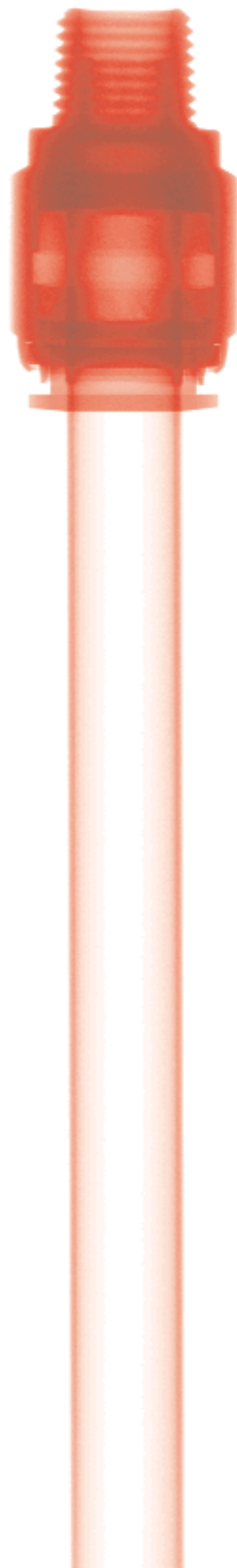

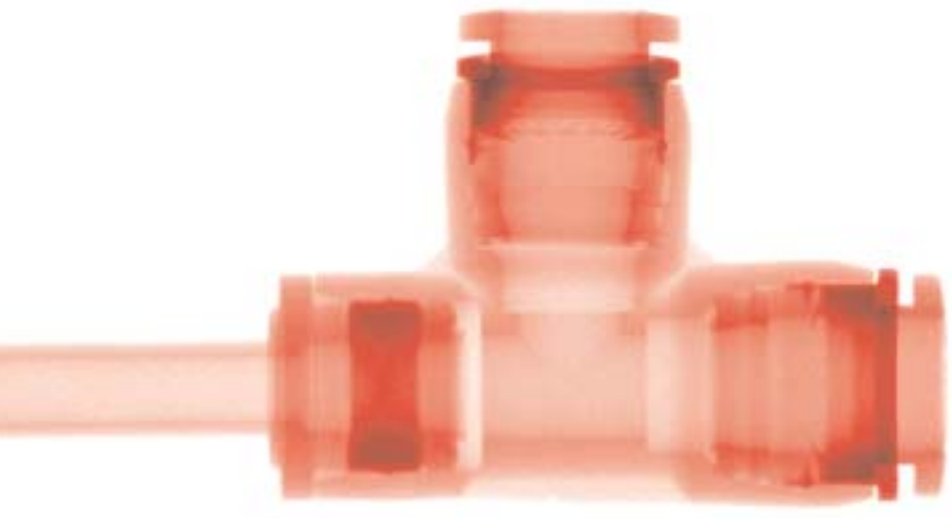

POPIS SPOJOVACÍCH PRVKŮ

Spojky Norgren Pneufit® C pro rychlou montáž bez použití nářadí a optimální průtok vzduchu.

Pneufit® C nabízí široký sortiment přes 1 000 kompozitních push-in pneumatických spojek, které doplňují naši základní řadu mosazných spojek série Pneufit®.

Mechanická pojistka z nerezové oceli umožňuje zajistit polyamidové a polyurethanové trubky (85 nebo 95 durometer).

Chemicky niklované díly z mosazi jsou odolné proti korozi, omezují usazování nečistot a prodlužují životnost.

Na kuželových závitech je nanášena těsnicí hmota, válcové závity jsou těsněné O kroužkem.

Přímé spojky mají pro montáž vnitřní a vnější šestihran.

Kvalitní těsnění neobsahují silikon.

Montážní otvory jsou na všech spojkách.

Nová řada miniaturních spojek Pneufit® M umožňuje montáž na velmi malém prostoru.



- >> 01 ROZŠÍŘENÍ METRICKÉ ŘADY
- 02 PROVEDENÍ S VNITŘÍM ZÁVITEM
- 03 ÚHLOVÉ SPOJKY S REGULACÍ PRŮTOKU.



TECHNICKÁ DATA

Provozní tlak: 750mm Hg vakuum, do 10 bar

Provozní teplota: 0 do 60°C

Medium: stlačený vzduch

MATERIÁLY

Nárazuvzdorné těleso: PBT

Těsnění: NBR (bez silikonu) pro U-manžety a O-kroužky

Závitová tělesa: chemicky niklovaná mosaz

Uvolňovací kroužek a zajišťovací kroužek: POM

Mechanická pojistka: nerezová ocel

Kroužek: chemicky niklovaná mosaz

Závitové těsnění: threebond 2350B

VELIKOSTI TRUBIČEK

Standardní velikosti: 4, 6, 8, 10, 12, 16 mm

Miniaturní velikosti: 3, 4, a 6mm

(velikosti v palcích jsou také možné)

ROZMĚRY ZÁVITŮ

Standardní rozměry: M5, M6, 1/8", 1/4", 3/8" a 1/2"

ISO G a ISO Rc

Miniaturní rozměry: M3, M5 a 1/8" ISO Rc

TYPY TRUBIČEK

Polyamid 11 nebo 12

Polyurethan 85, 95 nebo 98 durometer

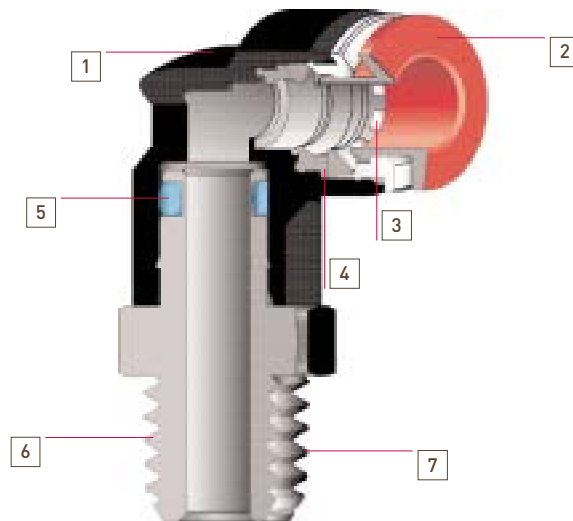

- | | |
|---|--|
| <p>1 Nárazuvzdorné PBT těleso černé pro Pneufit® C a světle šedé pro Pneufit® M.</p> <p>2 Rozpojovací objímky jsou červené pro metrické prvky, šedé pro palcové a světle šedé oválné pro Pneufit® M.</p> <p>3 Nerezová kleštinka speciální konstrukce pro sevření měkkých trubiček a umožňující snadné uvolnění.</p> <p>4 U - manžeta bez silikonu pro boční utěsnění trubičky.</p> | <p>5 Těsnící kroužek čepu otočného o 360°.</p> <p>6 Chemicky niklované mosazné závit, pro závit NPT je šestihran rýhovaný.</p> <p>7 Kuželové závit jsou opatřeny těsnící hmotou a válcové závit jsou těsněny O-kroužkem..</p> |
|---|--|

METRICKÁ ŘADA PNEUFIT® C

Přímá spojka

(s vnějším a vnitřním šestihranem)



	4mm	6mm	8mm	10mm	12mm	16mm
M5	C02250405	C02250605	-	-	-	-
M6	C02250406	C02250606	-	-	-	-
1/8" R	C01250418	C01250618	C01250818	C01251018	C01251218	-
1/4" R	C01250428	C01250628	C01250828	C01251028	C01251228	-
3/8" R	C01250438	C01250638	C01250838	C01251038	C01251238	C01251638
1/2" R	-	C01250648	C01250848	C01251048	C01251248	C01251648
1/8" G	C02250418	C02250618	C02250818	C02251018	-	-
1/4" G	C02250428	C02250628	C02250828	C02251028	C02251228	-
3/8" G	C02250438	C02250638	C02250838	C02251038	C02251238	C02251638
1/2" G	-	-	C02250848	C02251048	C02251248	C02251648

Přímá spojka

(pouze s vnitřním šestihranem)



M5	C022A0405	C022A0605	-	-	-	-
M6	C022A0406	C022A0606	-	-	-	-
1/8" R	C012A0418	C012A0618	C012A0818	C012A1018	C012A1218	-
1/4" R	C012A0428	C012A0628	C012A0828	C012A1028	C012A1228	-
3/8" R	C012A0438	C012A0638	C012A0838	C012A1038	C012A1238	-
1/2" R	-	-	C012A0848	C012A1048	C012A1248	-

Přímá spojka

(s vnitřním závitem)



M5	C02260405	-	-	-	-	-
1/8" G	C02260418	C02260618	C02260818	C02261018	-	-
1/4" G	C02260428	C02260628	C02260828	C02261028	C02261228	-
3/8" G	C02260438	C02260638	C02260838	C02261038	C02261238	-
1/2" G	-	-	C02260848	C02261048	C02261248	-

Přímá spojka

(stěnové provedení s vnitřním závitem)



1/8" G	C02320418	C02320618	C02320818	-	-	-
1/4" G	C02320428	C02320628	C02320828	C02321028	C02321228	-
3/8" G	C02320438	C02320638	C02320838	C02321038	C02321238	-
1/2" G	-	-	-	C02321048	C02321248	-

Úhlová otočná spojka 90°



M5	C02470405	C02470605	-	-	-	-
M6	C02470406	C02470606	-	-	-	-
1/8" R	C01470418	C01470618	C01470818	C01471018	C01471218	-
1/4" R	C01470428	C01470628	C01470828	C01471028	C01471228	-
3/8" R	C01470438	C01470638	C01470838	C01471038	C01471238	C01471638
1/2" R	-	C01470648	C01470848	C01471048	C01471248	C01471648
1/8" G	C02470418	C02470618	C02470818	C02471018	-	-
1/4" G	C02470428	C02470628	C02470828	C02471028	C02471228	-
3/8" G	C02470438	C02470638	C02470838	C02471038	C02471238	C02471638
1/2" G	-	-	C02470848	C02471048	C02471248	C02471648

Úhlová otočná spojka 90°

(prodloužená)



M5	C02540405	C02540605	-	-	-	-
M6	C02540406	C02540606	-	-	-	-
1/8" R	C01540418	C01540618	C01540818	C01541018	C01541218	-
1/4" R	C01540428	C01540628	C01540828	C01541028	C01541228	-
3/8" R	C01540438	C01540638	C01540838	C01541038	C01541238	C01541638
1/2" R	-	C01540648	C01540848	C01541048	C01541248	C01541648

Úhlová otočná spojka 90°

(s vnitřním závitem)



M5	C02480405	C02480605	-	-	-	-
M6	C02480406	C02480606	-	-	-	-
1/8" R	C01480418	C01480618	C01480818	-	-	-
1/4" R	C01480428	C01480628	C01480828	C01481028	C01481228	-
3/8" R	-	C01480638	C01480838	C01481038	C01481238	-
1/2" R	-	-	-	C01481048	C01481248	-

Y spojka otočná

(s rovnoběžnými vývody)



M5	C02880405	C02880605	-	-	-	-
M6	C02880406	C02880606	-	-	-	-
1/8" R	C01880418	C01880618	C01880818	C01881018	C01881218	-
1/4" R	C01880428	C01880628	C01880828	C01881028	C01881228	-
3/8" R	C01880438	C01880638	C01880838	C01881038	C01881238	-
1/2" R	-	C01880648	C01880848	C01881048	C01881248	-
1/8" G	C02880418	C02880618	C02880818	C02881018	-	-
1/4" G	C02880428	C02880628	C02880828	C02881028	C02881228	-
3/8" G	C02880438	C02880638	C02880838	C02881038	C02881238	-
1/2" G	-	C02880648	C02880848	C02881048	C02881248	-

METRICKÁ ŘADA PNEUFIT® C

T spojka otočná



	4mm	6mm	8mm	10mm	12mm	16mm
M5	C02670405	C02670605	-	-	-	-
M6	C02670406	C02670606	-	-	-	-
1/8" R	C01670418	C01670618	C01670818	C01671018	C01671218	-
1/4" R	C01670428	C01670628	C01670828	C01671028	C01671228	-
3/8" R	C01670438	C01670638	C01670838	C01671038	C01671238	C01671638
1/2" R	-	C01670648	C01670848	C01671048	C01671248	C01671648
1/8" G	C02670418	C02670618	C02670818	C02671018	-	-
1/4" G	C02670428	C02670628	C02670828	C02671028	C02671228	-
3/8" G	C02670438	C02670638	C02670838	C02671038	C02671238	C02671638
1/2" G	-	C02670648	C02670848	C02671048	C02671248	C02671648



T spojka otočná

(s bočním závitem)



M5	C02680405	C02680605	-	-	-	-
M6	C02680406	C02680606	-	-	-	-
1/8" R	C01680418	C01680618	C01680818	C01681018	C01681218	-
1/4" R	C01680428	C01680628	C01680828	C01681028	C01681228	-
3/8" R	C01680438	C01680638	C01680838	C01681038	C01681238	-
1/2" R	-	C01680648	C01680848	C01681048	C01681248	-
1/8" G	C02680418	C02680618	C02680818	C02681018	-	-
1/4" G	C02680428	C02680628	C02680828	C02681028	C02681228	-
3/8" G	C02680438	C02680638	C02680838	C02681038	C02681238	-
1/2" G	-	-	C02680848	C02681048	C02681248	-



T spojka otočná

(s vnitřním závitem)



M5	C026C0405	C026C0605	-	-	-	-
M6	C026C0406	C026C0606	-	-	-	-
1/8" R	C016C0418	C016C0618	C016C0818	C016C1018	-	-
1/4" R	C016C0428	C016C0628	C016C0828	C016C1028	C016C1228	-
3/8" R	-	C016C0638	C016C0838	C016C1038	C016C1238	-
1/2" R	-	-	C016C0848	C016C1048	C016C1248	-

Úhlová otočná spojka



M5	C0A510405	C0A510605	-	-	-	-
M6	C0A510406	C0A510606	-	-	-	-
1/8" G	C0A510418	C0A510618	C0A510818	-	-	-
1/4" G	C0A510428	C0A510628	C0A510828	C0A511028	-	-
3/8" G	-	C0A510638	C0A510838	C0A511038	C0A511238	-
1/2" G	-	-	C0A510848	C0A511048	C0A511248	-

Úhlová otočná spojka

(s horním vstupem)



M5	C0D510405	C0D510605	-	-	-	-
1/8" R	C0E510418	C0E510618	C0E510818	-	-	-
1/4" R	C0F510428	C0F510628	C0F510828	C0F511028	-	-
3/8" R	-	C0G510638	C0G510838	C0G511038	C0G511238	-

Úhlová otočná spojka s regulací průtoku

(směrem ven)



M5	C0K510405	C0K510605	-	-	-	-
1/8" R	C0TA00418	C0TA00618	C0TA00818	-	-	-
1/4" R	C0TA00428	C0TA00628	C0TA00828	C0TA01028	C0TA01228	-
3/8" R	-	C0TA00638	C0TA00838	C0TA01038	C0TA01238	-
1/2" R	-	-	C0TA00848	C0TA01048	C0TA01248	-
1/8" G	C0K510418	C0K510618	C0K510818	-	-	-
1/4" G	C0K510428	C0K510628	C0K510828	C0K511028	C0K511228	-
3/8" G	-	C0K510638	C0K510838	C0K511038	C0K511238	-
1/2" G	-	-	C0K510848	C0K511048	C0K511248	-



Úhlová spojka s regulací průtoku

(směrem ven)



M5	C0KB00405	C0KB00605	-	-	-	-
1/8" R	C0TB00418	C0TB00618	C0TB00818	-	-	-
1/4" R	C0TB00428	C0TB00628	C0TB00828	C0TB01028	C0TB01228	-
3/8" R	-	C0TB00638	C0TB00838	C0TB01038	C0TB01238	-
1/2" R	-	-	C0TB00848	C0TB01048	C0TB01248	-
1/8" G	C0KB00418	C0KB00618	C0KB00818	-	-	-
1/4" G	C0KB00428	C0KB00628	C0KB00828	C0KB01028	C0KB01228	-
3/8" G	-	C0KB00638	C0KB00838	C0KB01038	C0KB01238	-
1/2" G	-	-	C0KB00848	C0KB01048	C0KB01248	-

























In line regulátor průtoku



-	C00GE0400	C00GE0600	C00GE0800	C00GE1000	C00GE1200	-
---	-----------	-----------	-----------	-----------	-----------	---

METRICKÁ ŘADA PNEUFIT® C

Přímá spojka		4mm	6mm	8mm	10mm	12mm	16mm		
		C00200400	C00200600	C00200800	C00201000	C00201200	C00201600		
Stěnová přímá spojka		C00290400	C00290600	C00290800	C00291000	C00291200	-		
Nástrčná dutinka		C00220400	C00220600	C00220800	C00221000	C00221200	C00221600		
Zátka		C00040400	C00040600	C00040800	C00041000	C00041200	C00041600		
Nástrčná záslepka		C00120400	C00120600	C00120800	C00121000	C00121200	C00121600		
Úhlová spojka		C00400400	C00400600	C00400800	C00401000	C00401200	C00401600		
Úhlová spojka s nástrčnou trubkou		C00430400	C00430600	C00430800	C00431000	C00431200	C00431600		
T spojka		C00600400	C00600600	C00600800	C00601000	C00601200	C00601600		
T spojka s nástrčnou trubkou		C00630400	C00630600	C00630800	C00631000	C00631200	-		
T spojka s boční nástrčnou trubkou		C00640400	C00640600	C00640800	C00641000	C00641200	-		
Y spojka		C00820400	C00820600	C00820800	C00821000	C00821200	-		
Y spojka s nástrčnou trubkou		C00840400	C00840600	C00840800	C00841000	C00841200	-		
Křížová spojka		C00900400	C00900600	C00900800	C00901000	C00901200	-		
Přímá spojka (redukční)		6 - 4mm	8 - 4mm	8 - 6mm	10 - 6mm	10 - 8mm	12 - 8mm	12 - 10mm	16 - 12mm
		C00200604	-	C00200806	-	C00201008	-	C00201210	C00201612
Přímá spojka s nástrčnou trubkou (redukční - trubka/hadice)		C00230604	C00230804	C00230806	C00231006	C00231008	C00231208	C00231210	C00231612
Přímá spojka s nástrčnou trubkou (redukční - trubka/hadice)		C00230406	-	C00230608	-	-	-	-	-
Nástrčná dutinka (redukční)		C00220604	-	C00220806	-	C00221008	-	C00221210	C00221612
T spojka (redukční)		C006A0604	-	C006A0806	C006A1006	C006A1008	C006A1208	C006A1210	C006A1612
T spojka s nástrčnou trubkou (redukční)		C00640604	-	C00640806	-	C00641008	-	C00641210	-
T spojka s boční nástrčnou trubkou (redukční)		C00630604	-	C00630806	-	C00631008	-	C00631210	-
Y spojka (redukční)		C00820604	-	C00820806	-	C00821008	-	C00821210	-
Y spojka s nástrčnou trubkou (redukční)		C00840604	-	C00840806	-	C00841008	-	C00841210	-

MINIATURNÍ SPOJKY ŘADY PNEUFIT® M

Přímá spojka

(s vnějším a vnitřním šestihranem)



	3mm	4mm	6mm
M3	M02250303	M02250403	-
M5	M02250305	M02250405	M02250605
M6	M02250306	M02250406	M02250606
1/8"	-	M01250418	M01250618

Přímá spojka

(pouze s vnitřním šestihranem)



	3mm	4mm	6mm
M3	M022A0303	M022A0403	-
M5	M022A0305	M022A0405	M022A0605
M6	M022A0306	M022A0406	M022A0606
1/8"	-	M012A0418	M012A0618

Přímá spojka

(s vnitřním závitem)



	3mm	4mm	6mm
M3	M02260303	M02260403	-
M5	M02260305	M02260405	M02260605
M6	M02260306	M02260406	M02260606
1/8"	-	M01260418	M01260618

Úhlová otočná spojka 90°



	3mm	4mm	6mm
M3	M02470303	M02470403	-
M5	M02470305	M02470405	M02470605
M6	M02470306	M02470406	M02470606
1/8"	-	M01470418	M01470618

T spojka otočná



	3mm	4mm	6mm
M3	M02670303	M02670403	-
M5	M02670305	M02670405	M02670605
M6	M02670306	M02670406	M02670606
1/8"	-	M01670418	M01670618

T spojka otočná

(s bočním závitem)



	3mm	4mm	6mm
M3	M02680303	M02680403	-
M5	M02680305	M02680405	M02680605
M6	M02680306	M02680406	M02680606
1/8"	-	M01680418	M01680618

Přímá spojka



	3mm	4mm	6mm
-	M00200300	M00200400	M00200600

Úhlová spojka s držákem



	3mm	4mm	6mm
-	M00400300	M00400400	M00400600

T spojka s držákem



	3mm	4mm	6mm
-	M00600300	M00600400	M00600600

Přímá spojka

(redukční)



	4 - 3mm	6 - 3mm	6 - 4mm
-	M00200403	M00200603	M00200604

Úhlová spojka s regulací průtoku



	3mm	4mm	6mm
M5	C0K510305	C0K510405	C0K510605



01

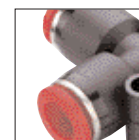

02



03

- » 01 OVÁLNÝ UVOLŇOVACÍ KROUŽEK
02 MONTÁŽNÍ OTVORY NA ŠROUBENÍCH
03 PROVEDENÍ S VNITŘÍM ZÁVITEM

RUČNĚ OVLÁDANÉ VENTILY ŘADY PNEUFIT® C

Ručně ovládané ventily

(závit/závit)



	R1/8	R1/4	R3/8	R1/2
	C01GG1818	C01GG2828	C01GG3838	C01GG4848

Ručně ovládané ventily

(trubka/trubka)



	6mm	8mm	10mm	12mm
	C00GF0600	C00GF0800	C00GF1000	C00GF1200

Ručně ovládané ventily

trubka (na vstupu)/závit (na výstupu)



	1/8" R	1/4" R	3/8" R	1/2" R
	C01GH 0618	C01GH 0818	-	-
	C01GH 0628	C01GH 0828	C01GH 1028	C01GH 1228
	C01GH 0638	C01GH 0838	C01GH 1038	C01GH 1238
	-	-	C01GH 1048	C01GH 1248

Ručně ovládané ventily

závit (na vstupu)/trubka (na výstupu)



	1/8" R	1/4" R	3/8" R	1/2" R
	C01GJ 0618	C01GJ 0818	-	-
	C01GJ 0628	C01GJ 0828	C01GJ 1028	C01GJ 1228
	C01GJ 0638	C01GJ 0838	C01GJ 1038	C01GJ 1238
	-	-	C01GJ 1048	C01GJ 1248

VÍCENÁSOBNÉ ROZBOČOVACÍ DÍLY ŘADY PNEUFIT® C

Vícenásobný rozbočovací díl s vnějším závitem



	6 - 4mm	8 - 4mm	8 - 6mm	10 - 8mm
1/8" R	C01D3 0418	-	-	-
1/4" R	-	C01D3 0428	C01D3 0628	-
3/8" R	-	-	-	C01D3 0838

Vícenásobný rozbočovací díl



	6 - 4mm	8 - 4mm	8 - 6mm	10 - 6mm	10 - 8mm
	C00D3 0604	C00D3 0804	C00D3 0806	C00D3 1006	C00D3 1008

Vícenásobný rozbočovací díl s nástrčnou trubkou



	6 - 4mm	8 - 4mm	8 - 6mm	10 - 6mm	10 - 8mm
	C00J3 0604	C00J3 0804	C00J3 0806	-	C00J3 1008

AUSTRÁLIE

Tel: +61 3 921 30 800
Fax: +61 3 921 30 890
enquiry@norgren.com.au

BELGIE & LUCEMBURSKO

Tel: +32 2 333 44 11
Fax: +32 2 376 26 34
enquiry@be.norgren.com

BRAZÍLIE

Tel: +55 11 5698 4000
Fax: +55 11 5698 4001
vendas@norgren.com.br

ČESKÁ REPUBLIKA

Tel: +420 465 612 879
Fax: +420 465 612 908
info@cz.norgren.com

ČÍNA

Tel: +86 21 64 85 69 09
Fax: +86 21 64 95 60 42
norgren@online.sh.cn

DÁNSKO

Tel: +45 44 91 41 66
Fax: +45 44 91 15 60
norgren@norgren.dk

FINSKO

Tel: +358 95 712 140
Fax: +358 95 712 1440
arki@norgren.fi

FRANCIE

Tel: +33 1 60 05 92 12
Fax: +33 1 60 06 08 52
norgren@norgren.fr

HOLANDSKO

Tel: +31 20 6822751
Fax: +31 20 6820983
enquiry@nl.norgren.com

HONG KONG

Tel: +852 2492 7608
Fax: +852 2498 5878
enquiry@norgren.com.hk

INDIE

Tel: +91 11 2681 7933
Fax: +91 11 2681 7932
enquiry@norgren.co.in.

IRSKO

Tel: +353 1 8300 288
Fax: +353 1 8300 082
norgren@indigo.ie

ITÁLIE

Tel: +39 039 60 631
Fax: +39 039 60 63 301
d.aziendale@norgrenitalia.it

JAPONSKO

Tel: +81 6 6876 8913
Fax: +81 6 6876 8929
Japan@imi-norgren.com

KANADA

Tel: +1 303 794 2611
Fax: +1 303 795 9487
inquiry@usa.norgren.com

MALAJSIE

Tel: +60 3 5121 9255
Fax: +60 3 5121 2889
enquiry@norgren.com.my

MAĎARSKO

Tel: +36 1 284 9000
Fax: +36 1 284 8980
budapest@norgren.hu

MEXIKO

Tel: +52 55 1500 64 00
Fax: +52 55 5565 70 72
neumatica@norgren.com.mx

NORSKO

Tel: +47 67 90 82 01
Fax: +47 67 97 06 24
norgren@norgren.no

NOVÝ ZÉLAND

Tel: +64 9 579 0189
Fax: +64 9 526 3398
enquiry@norgren.co.nz

NĚMECKO

Tel: +49 2802 49-0
Fax: +49 2802 49356
info@norgren.de

POLSKO

Tel: +48 22 518 9530
Fax: +48 22 518 9531
biuro@pl.norgren.com

RAKOUSKO

Tel: +43 22 36 63 520
Fax: +43 22 36 63 520 20
enquiry@at.norgren.com

SINGAPUR

Tel: +65 6862 1811
Fax: +65 6862 1916/17
enquiry@sg.norgren.com

SLOVINSKO

Tel: +386 4 531 7550
Fax: +386 4 531 7555
info@si.norgren.com

ŠPANĚLSKO

Tel: +34 93 748 9800
Fax: +34 93 783 0838
norgren@norgren.es

ŠVÉDSKO

Tel: +46 40 59 51 00
Fax: +46 40 49 50 90
info@norgren.se

ŠVÝCARSKO

Tel: +41 71 973 82 00
Fax: +41 71 973 82 01
norgren@norgren.ch

VELKÁ BRITÁNIE

Tel: +44 1543 265 000
Fax: +44 1543 265 811
enquiry@uk.norgren.com

USA

Tel: +1 303 794 2611
Fax: +1 303 795 9487
inquiry@usa.norgren.com

Podporováno světovými distributory
www.norgren.com

Společnost "Norgren" a "IMI" je
registrováno pod obchodní značkou
© IMI Norgren Limited 2005.
Naše činnosti podléhají nepřetržitému
vývoji, proto si Norgren vyhrazuje
právo měnit specifikace bez
předchozího upozornění.

z6825 IPS CZ./07/05